

FEATURES

- **Compact and lightweight**
Charged with hydrogen gas for high arc cooling capacity, short gap cutoff has been achieved at high DC voltages.
- **Safety**
High safety achieved with construction that prevents explosions by keeping the arc from leaking.
- **High contact reliability**
Since the contact portion is sealed in hydrogen gas, there is no contact oxidation. It is also dustproof and waterproof.

TYPICAL APPLICATIONS

- High DC voltage applications such as
- **Electric vehicle**
 - **Hybrid vehicle**
 - **Fuel-cell vehicle**
 - **Battery charge and discharge systems**
 - **Construction equipment**



RoHS compliant

ORDERING INFORMATION

AEV 0

Contact arrangement

- 1: 1 Form A (Screw terminal, 10A TM, with terminal protection cover)
- 5: 1 Form A (20A TM type)

Contact rating

- 1: 10 A
- 2: 20 A
- 8: 80 A
- 4: 120 A
- 7: 200 A
- 9: 300 A

Coil voltage

- 12: 12V DC
- 24: 24V DC

Coil terminal structure

- Nil: Plug-in (Faston) (for 20 A type), Connector (for 80 A, 120 A and 300 A), Lead wire (for 200 A)
- 2: Plug-in (Faston) (for 10 A type with terminal protection cover)

TYPES

Type	Nominal coil voltage	Contact arrangement	Part number
10 A	12 V DC	1 Form A	AEV110122
20 A			AEV52012
80 A			AEV18012
120 A			AEV14012
New 200 A			AEV17012
300 A			AEV19012
10 A	24 V DC	1 Form A	AEV110242
80 A			AEV18024
120 A			AEV14024
New 200 A			AEV17024
300 A			AEV19024

Standard packing: Carton: 25pcs. Case: 100pcs (for 10 A type)

Carton: 25pcs. Case: 50pcs (for 20 A type)

Carton: 1pc. Case: 20pcs (for 80 A type)

Carton: 1pc. Case: 20pcs (for 120 A type)

Carton: 1pc. Case: 10pcs (for 200 A type)

Carton: 1pc. Case: 5pcs (for 300 A type)

RATING

1. Coil data

Type	Nominal coil voltage	Pick-up voltage (at 20°C 68°F)	Drop-out voltage (at 20°C 68°F)	Nominal operating current [±10%] (at 20°C 68°F)	Nominal operating power (at 20°C 68°F)	Max. applied voltage
10 A	12 V DC	Max. 9 V DC	Min. 1 V DC	0.103 A	1.24 W	16 V DC
20 A		Max. 9 V DC	Min. 0.5 V DC	0.327 A	3.9 W	
80 A		Max. 9 V DC	Min. 1 V DC	0.353 A	4.2 W	
120 A		Max. 9 V DC	Min. 1 V DC	0.353 A	4.2 W	
200 A		Max. 9 V DC	Min. 1 V DC	0.500 A	6.0 W	
300 A		Max. 9 V DC	Min. 2 V DC	3.2 A (Inrush)	37.9 W (Inrush, approx. 0.1 sec.) 3.6 W (Stable)	
10 A	24 V DC	Max. 18 V DC	Min. 2 V DC	0.052 A	1.24 W	32 V DC
80 A		Max. 18 V DC	Min. 2 V DC	0.176 A	4.2 W	
120 A		Max. 18 V DC	Min. 2 V DC	0.176 A	4.2 W	
200 A		Max. 18 V DC	Min. 2 V DC	0.250 A	6.0 W	
300 A		Max. 18 V DC	Min. 4 V DC	1.85 A (Inrush)	44.4 W (Inrush, approx. 0.1 sec.) 3.8 W (Stable)	

EV (AEV)

2. Specifications

Characteristics	Item	Specifications						
		10A type	20A type	80A type	120 A type	200 A type	300 A type	
Contact rating	Contact arrangement	1 Form A						
	Nominal switching capacity (resistive load)	10A 400V DC	20A 400V DC	80A 400V DC	120A 400V DC (Carry current)	200A 400V DC	300A 400V DC	
	Short term current	15A 2min, 30A 30sec (2mm ²)	40A 10min, 60A 1min (3mm ²)	120A 15min, 180A 2min (15mm ²)	225A 3min, 400A 30sec. (38mm ²)	300A 15min, (60mm ²)	400A 10min, 600A 1min. (100mm ²)	
	Min. switching capacity (resistive load)* ¹	1A 12V DC* ¹	1A 12V DC* ¹	1A 12V DC* ¹	1A 12V DC* ¹	1A 12V DC* ¹	1A 24V DC* ¹	
	Max. cut-off current* ⁵	—	—	800A 300V DC (Min. 1 cycle)* ^{2, 5}	1,200A 300V DC (Min. 1 cycle)* ^{2, 5}	2,000A 350V DC (Min. 1 cycle)* ^{2, 5}	2,500A 300V DC (Min. 3 cycles)* ^{3, 5}	
	Overload opening/closing rating* ⁵	30A 400V DC (Min. 50 cycles)* ^{2, 5}	60A 400V DC (Min. 50 cycles)* ^{2, 5}	120A 400V DC (Min. 50 cycles)* ^{2, 5}	800A 300V DC (Min. 5 cycles)* ^{2, 5} 120A 400V DC (Min. 50 cycles)* ^{2, 5}	—	600A 400V DC (Min. 300 cycles)	
	Reverse direction cut-off* ⁵	—	—	-120A 200V DC (Min. 50 cycles)* ^{2, 5}	-120A 200V DC (Min. 50 cycles)* ^{2, 5}	-200A 200V DC (Min. 1,000 cycles)* ^{2, 5}	-300A 200V DC (Min. 100 cycles)	
	Contact voltage drop (Initial)	Max. 0.5V (By voltage drop 6 V DC 10A)	Max. 0.2V (By voltage drop 6 V DC 20A)	Max. 0.067V (By voltage drop 6 V DC 20A)	Max. 0.03V (By voltage drop 6 V DC 20A)	Max. 0.1V (200 A Carry current)	Max. 0.06V (300 A Carry current)	
Electrical characteristics	Insulation resistance (Initial)	Min. 100MΩ (at 500 V DC, Measurement at same location as "Initial breakdown voltage" section.)						
	Breakdown voltage (Initial)	Between open contacts	2,500Vrms/min. (Detection current: 10mA)					
		Between contact and coil	2,500Vrms/min. (Detection current: 10mA)					
	Operate time (at 20°C 68°F)	Max. 50ms (Nominal coil voltage applied to the coil, excluding contact bounce time.)					Max. 30ms (Nominal coil voltage applied to the coil, excluding contact bounce time.)	
Release time (at 20°C 68°F)	Max. 30ms (Nominal coil voltage applied to the coil, without diode.)					Max. 10ms (Nominal coil voltage applied to the coil, without diode.)		
Mechanical characteristics	Shock resistance	Functional	Min. 196m/s ² {20 G} (Half-wave pulse of sine wave: 11ms; detection time: 10μs)	For ON: Min. 196m/s ² {20 G} (Half-wave pulse of sine wave: 11ms; detection time: 10μs) For OFF: Min. 98m/s ² {10 G} (Half-wave pulse of sine wave: 11ms; detection time: 10μs)				
		Destructive	Min. 490 m/s ² {50 G} (Half-wave pulse of sine wave: 6ms)					
	Vibration resistance	Functional	10 to 200 Hz, Min.43 m/s ² {4.4 G} (Detection time: 10μs)					10 to 200 Hz, Min. 44 m/s ² {4.5 G} (Detection time: 10μs)
		Destructive	10 to 200 Hz, Min.43 m/s ² {4.4 G} (Time of vibration for each direction; X, Y, Z direction: 4 hours)					10 to 200 Hz, Min. 44 m/s ² {4.5 G} (Time of vibration for each direction; X, Y, Z direction: 4 hours)
Expected life	Mechanical	Min. 10 ⁵	Min. 2×10 ⁵					
	Electrical (resistive load)	10A 400V DC Min. 75,000* ²	20A 400V DC Min. 3,000* ²	80A 400V DC Min. 1,000* ²	30A 400V DC Min. 3,000* ²	200A 400V DC Min. 3,000* ²	300A 400V DC Min. 1,000	
Conditions	Conditions for operation, transport and storage	Ambient temperature: -40 to +80°C -40 to +176°F (Storage: Max. 85°C 185°F), Humidity: 5 to 85% R.H. (Not freezing and condensing at low temperature)				Ambient temperature: -40 to +85°C -40 to +185°F (Storage: Max. 85°C 185°F), Humidity: 5 to 85% R.H. (Not freezing and condensing at low temperature)		
Mass (Approx.)		90 g 3.17 oz	180 g 6.35 oz	400 g 14.11 oz	400 g 14.11 oz	600 g 21.16 oz	750 g 26.46 oz	

- Notes: *1. This value can change due to the switching frequency, environmental conditions, and desired reliability level, therefore it is recommended to check this with the actual load.
*2. The electrical load performance value for the 10A, 20A, 80A, 120A and 200A types applies when a varistor is connected in parallel to the coil. Please be warned that working life will be reduced when a diode is used.
*3. Condition: Nominal switching 10 cycles, each cut-off 2,500 A
*4. The coil voltage 12 V DC type and 24 V DC type have the same specifications.
*5. at L/R ≤ 1ms

REFERENCE DATA

1.-(1) Ambient temperature characteristics (10 A type)
Sample: EV relay 10 A, 3 pcs.

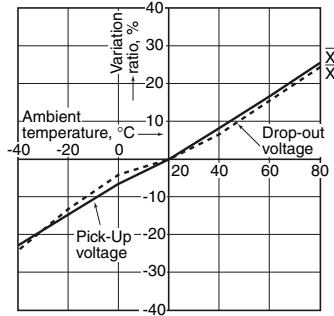

1.-(2) Ambient temperature characteristics (20 A type)
Sample: EV relay 20 A, 3 pcs.

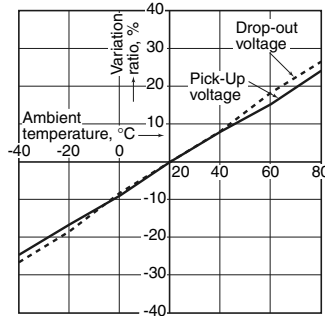

1.-(3) Ambient temperature characteristics (80 A type)
Sample: EV relay 80 A, 3 pcs.

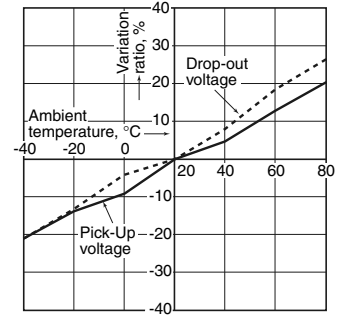

1.-(4) Ambient temperature characteristics (120 A type)
Sample: EV relay 120 A, 3 pcs.

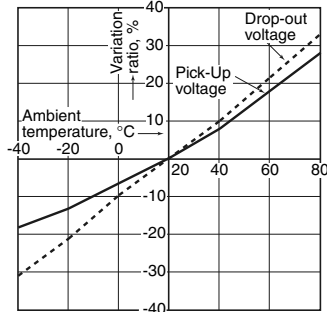

1.-(5) Ambient temperature characteristics (200 A type)
Sample: EV relay 200 A, 3 pcs.

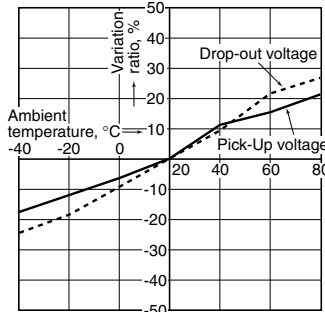

1.-(6) Ambient temperature characteristics (300 A type)
Sample: EV relay 300 A, 3 pcs.

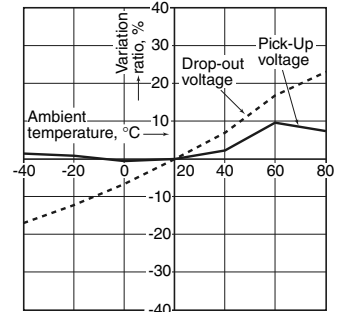

2. Max. value for switching capacity
When 400 V DC resistive load

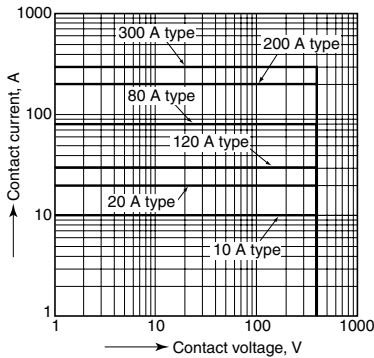

3. Switching life curve (Forward direction)
When 400 V DC resistive load

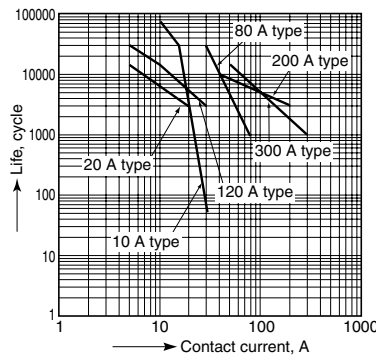

4. Cut-off life curve (Forward direction)

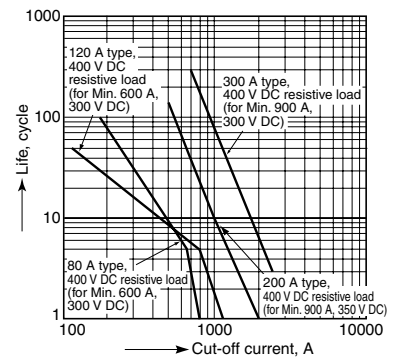

5. Carrying performance curve (80°C 176°F)
*For 200 A and 300 A, at 85°C 185°F

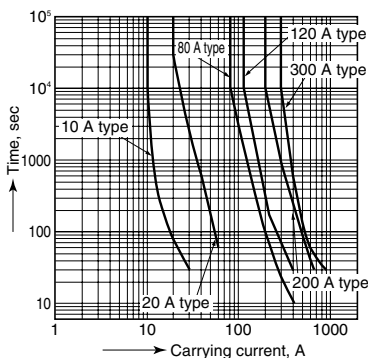

EV (AEV)

DIMENSIONS (mm inch)

The CAD data of the products with a **CAD Data** mark can be downloaded from: <http://industrial.panasonic.com/ac/e/>

1. 10 A type

CAD Data

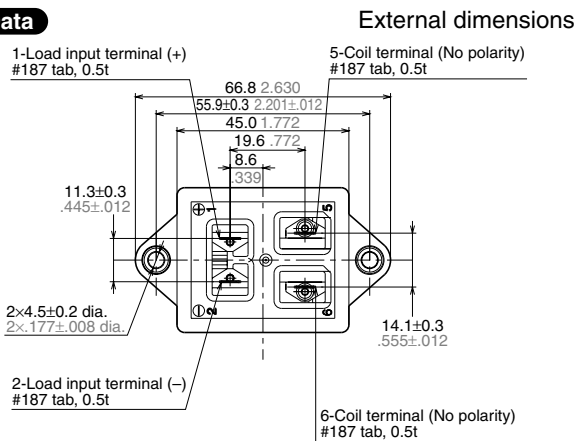

Schematic (TOP VIEW)

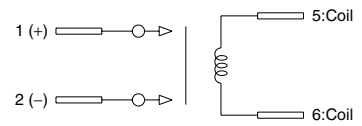

Load side has polarities (+) and (-)

Mounting dimensions

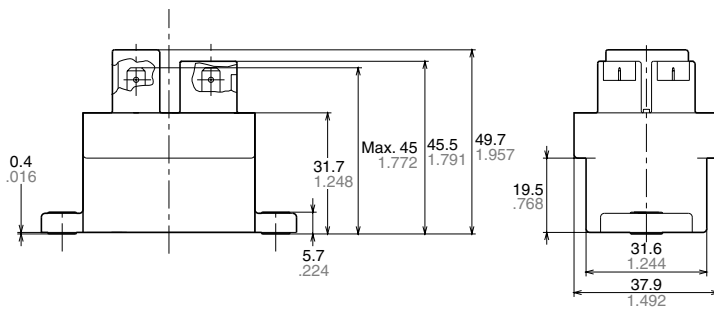
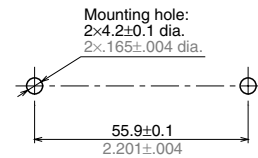

General tolerance:

less than 10 .394: ±0.3 ±.012
10 to 50 .394 to 1.969: ±0.6 ±.024
more than 50 1.969: ±1.0 ±.039

2. 20 A type

CAD Data

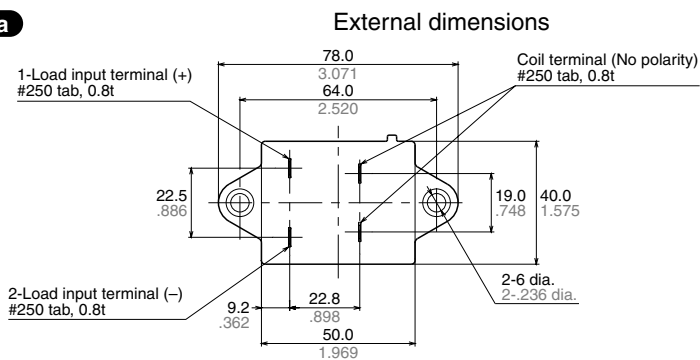

Schematic (TOP VIEW)

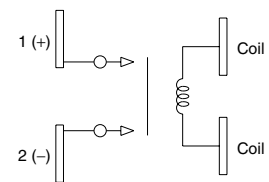

Load side has polarities (+) and (-)

Mounting dimensions

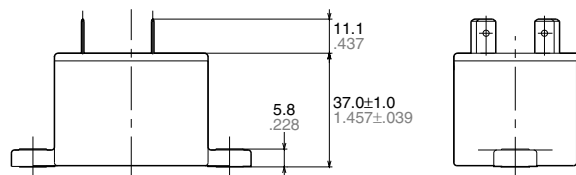
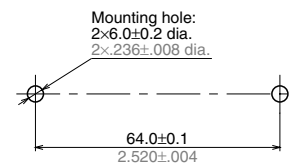

General tolerance:

less than 10 .394: ±0.3 ±.012
10 to 50 .394 to 1.969: ±0.6 ±.024
more than 50 1.969: ±1.0 ±.039

3. 80 A type

CAD Data

External dimensions

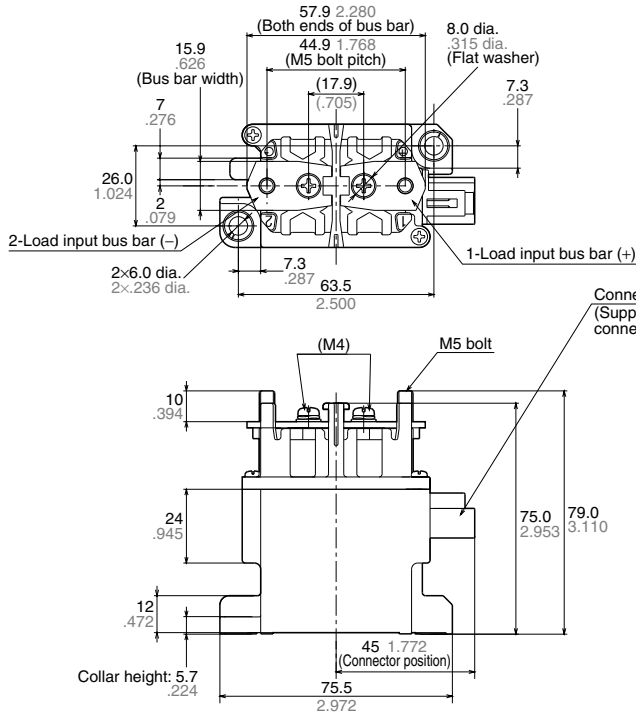

Connector part number: 7282-1020 (Yazaki)
(Supplement) Harness side female connector part number: 7283-1020 (*Note)

Schematic (TOP VIEW)

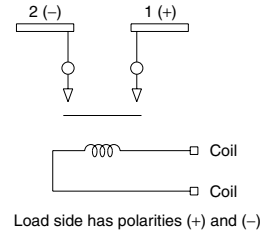

Mounting dimensions

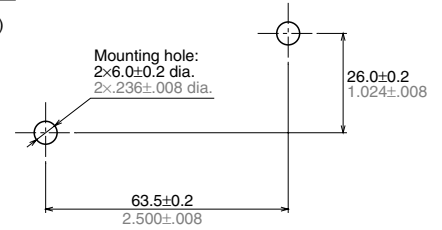

General tolerance:

less than 10 .394: ±0.3 ±.012
10 to 50 .394 to 1.969: ±0.6 ±.024
more than 50 1.969: ±1.0 ±0.39

*Note: Separate connection of the terminal and lead wire is required.

4. 120 A type

CAD Data

External dimensions

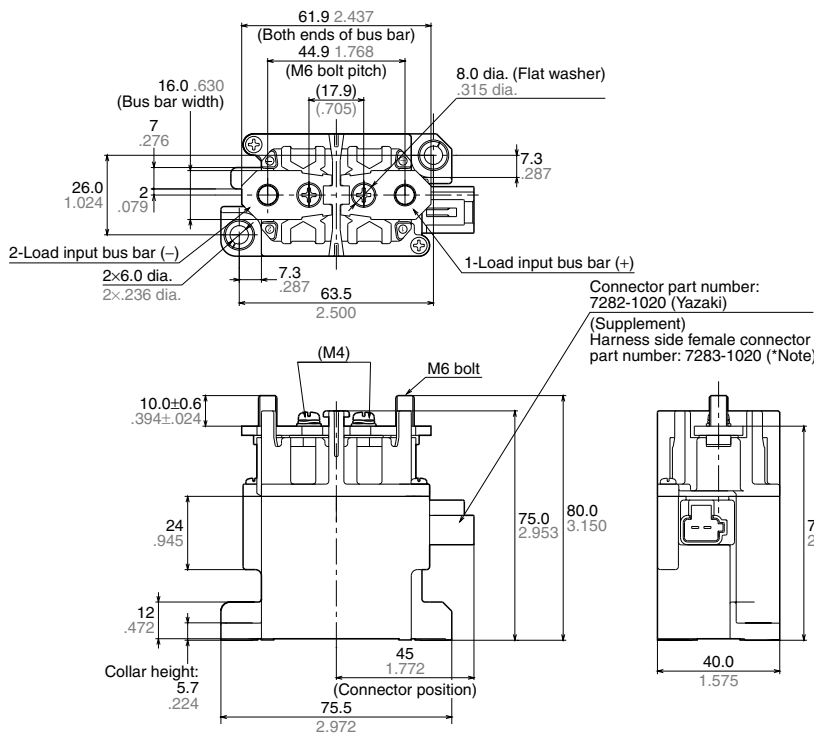

Connector part number: 7282-1020 (Yazaki)
(Supplement) Harness side female connector part number: 7283-1020 (*Note)

Schematic (TOP VIEW)

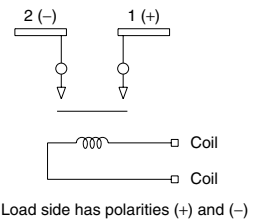

Mounting dimensions

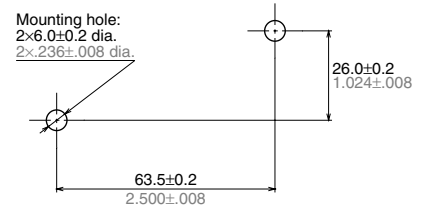

General tolerance:

less than 10 .394: ±0.3 ±.012
10 to 50 .394 to 1.969: ±0.6 ±.024
more than 50 1.969: ±1.0 ±0.39

*Note: Separate connection of the terminal and lead wire is required.

EV (AEV)

5. 200 A type

CAD Data

External dimensions

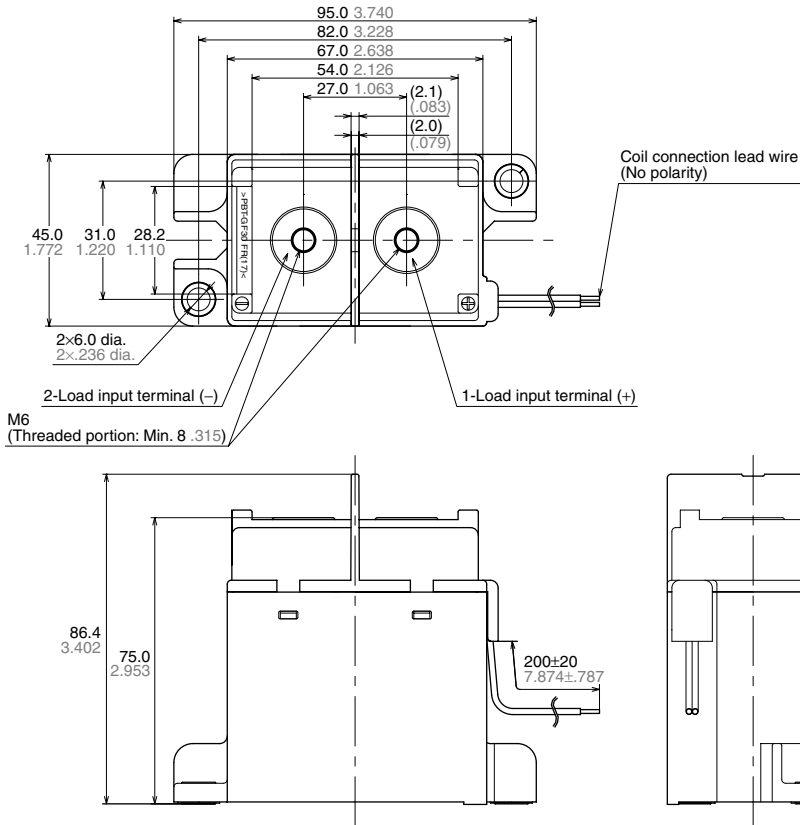

Schematic (TOP VIEW)

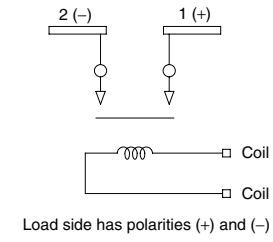

Mounting dimensions

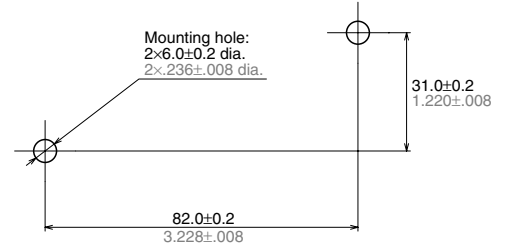

General tolerance:

less than 10 .394: ±0.3 ±.012
 10 to 50 .394 to 1.969: ±0.6 ±.024
 more than 50 1.969: ±1.0 ±.039

*Note: Separate connection of the terminal and lead wire is required.

6. 300 A type

CAD Data

External dimensions

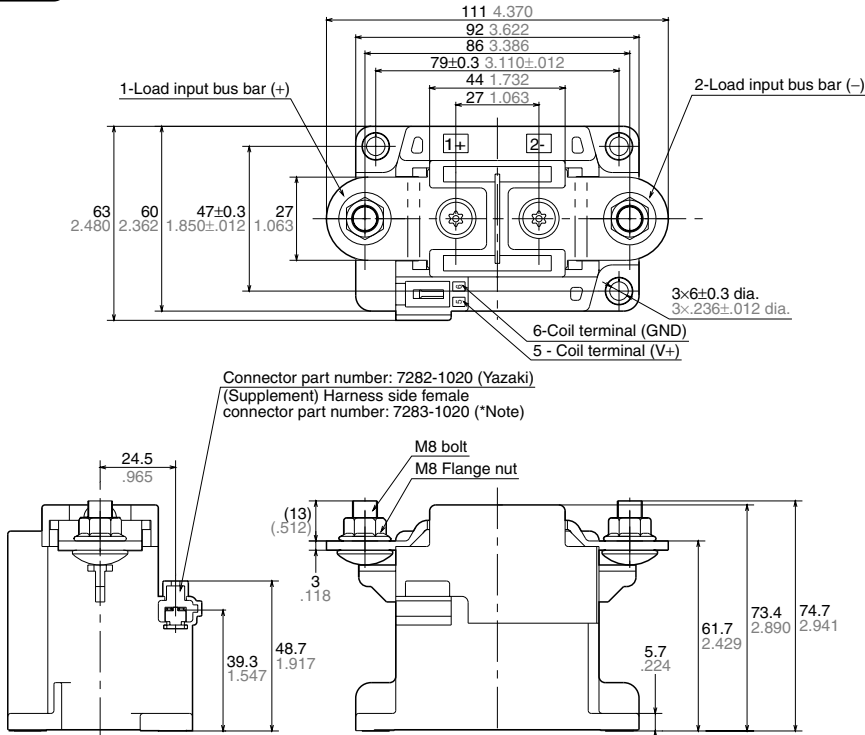

Schematic (TOP VIEW)

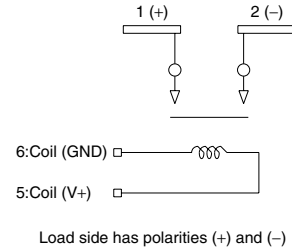

Mounting dimensions

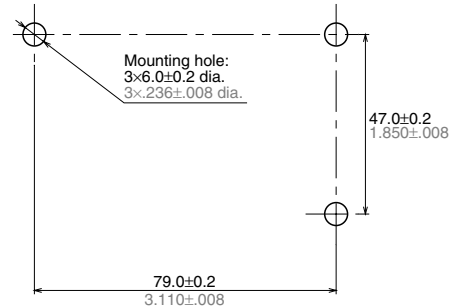

General tolerance:

less than 10 .394: ±0.3 ±.012
 10 to 50 .394 to 1.969: ±0.6 ±.024
 more than 50 1.969: ±1.0 ±.039
 more than 100 3.937: ±1.6 ±.063

*Note: Separate connection of the terminal and lead wire is required.

NOTES

1. Usage, transport and storage conditions

- 1) Temperature: -40 to $+80^{\circ}\text{C}$ -40 to $+176^{\circ}\text{F}$
- 2) Humidity: 5 to 85% RH (Avoid freezing and condensation.)
The humidity range varies with the temperature. Use within the range indicated in the graph below.
- 3) Atmospheric pressure: 86 to 106 kPa
Temperature and humidity range for usage, transport, and storage

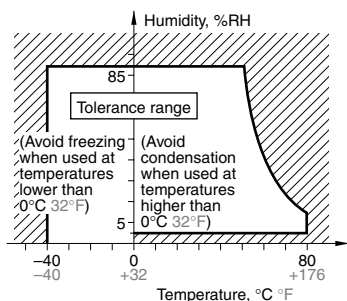

4) Condensation

Condensation forms when there is a sudden change in temperature under high temperature and high humidity conditions. Condensation will cause deterioration of the relay insulation.

5) Low temperature, low humidity environments

The plastic becomes brittle if the relay is exposed to a low temperature, low humidity environment for long periods of time.

2. When installing the relay, always use washers to prevent the screws from loosening.

- Regarding the torque value for contact terminal, it is intended that secure an electrical connection stability by getting enough contact pressure (Axial force) of fixing part.
Therefore, please do not use the screw (a bolt and a nut) preventing looseness needing running torque (Prevailing torque type and Self lock type) because enough tightening force in axial direction may not be secured.
In addition, there is high possibility that a case of a relay may be broken if users use the nut for EV80A and EV120A.
Because excessive torque is applied to a case of a relay before generation of contact pressure. (Axial force).
- Regarding the torque value for the main body of a relay, please use suitable screw on own verification.

3. Condition of tightening screw

Tighten each screw within the rated range given below.
Exceeding the maximum torque may result in breakage.
Mounting is possible in either direction.

<Relay attaching portion>

- M4 screw (for 10A type): 1.8 to 2.7 N·m
- M5 screw (for 20A, 80A, 120A, 200A and 300A types): 3 to 4 N·m

<Main terminal attaching portion>

- M5 (for 80A type): 3 to 4 N·m
- M6 (for 120A and 200A types): 6 to 8 N·m
- M8 (for 300A type): 10 to 12 N·m

4. Electrical life

This relay is a high-voltage direct-current switch. In its final breakdown mode, it may lose the ability to provide the proper cut-off. Therefore, do not exceed the indicated switching capacity and life. (Please treat the relay as a product with limited life and replace it when necessary.)

In the event that the relay loses cut-off ability, there is a possibility that burning may spread to surrounding parts, so configure the layout so that the power is turned off within one second.

5. Permeation life of internal gas

This relay uses a hermetically encased contact (capsule contact) with gas inside. The gas has a permeation life that is affected by the temperature inside the capsule contact (ambient temperature + temperature rise due to flow of electrical current). For this reason, make sure the ambient operating temperature is between -40 and 80°C -40 and $+176^{\circ}\text{F}$ (200A and 300A types: Max. 85°C 185°F), and the ambient storage temperature is between -40 and 85°C -40 and $+185^{\circ}\text{F}$.

6. The coils (300 A type) and contacts (all type) of the relay are polarized, so follow the connection schematic when connecting the coils and contacts.

Type 300 A contains a reverse surge voltage absorption circuit; therefore a surge protector is not needed.

7. For the 300 A type, drive the coil with a quick startup. (Built-in one-shot pulse generator circuit)

8. After the ON signal enters the 300A type, automatic coil current switching occurs after approximately 0.1 seconds. Do not repeatedly turn it OFF within that 0.1 seconds interval, as doing so may damage the relay.

9. Be careful that foreign matter and oils and fats kind don't stick to the main terminal parts because it is likely to cause terminal parts to give off unusual heat.

Also, please use the following materials for connected harnesses and bus bars.

- 10A type: Min. 2 mm² nominal cross-sectional area
- 20A type: Min. 3 mm² nominal cross-sectional area
- 80A type: Min. 15 mm² nominal cross-sectional area
- 120A type: Min. 38 mm² nominal cross-sectional area
- 200A type: Min. 60 mm² nominal cross-sectional area
- 300A type: Min. 100 mm² nominal cross-sectional area

10. As a guide, the insertion strength of the plug-in terminal into the relay tab terminal should be 40 to 70N (10A type), 40 to 80N (20A type). Please select a plug-in terminal (flat connection terminal) which comply with JIS C2809-1999.

10A type: for plate thickness 0.5mm and #187 tab terminal
20A type: for plate thickness 0.8mm and #250 tab terminal

11. Avoid excessive load applied to the terminal in case of installing such as a bus bar etc., Because it might adversely affect the opening and closing performance.

12. Use the specified connector for the connector terminal connection (80A, 120A and 300A)

Yazaki Corporation 7283 – 1020 or equivalent

EV (AEV)

13. Cautions for use

- 1) Regarding cautions for use and explanation of technical terms, please refer to our "Automotive Relays Automation Controls Group Catalog".
- 2) Additionally the ambient temperature and condition for your application should be considered because pick-up and drop-out voltage will be changed.
- 3) If it includes ripple, the ripple factor should be less than 5%. For coil surge absorption, please use a zener diode or varistor, etc., so that the clamp voltage reaches 1.5 times or more (at least 18 V for rated 12 V type) the rated operation voltage. If only a diode is connected in parallel with the relay coil, the contact opening velocity will become slow and sufficient cutoff performance cannot be guaranteed. Please avoid such usage.

Ex. 1: When using a varistor

Recommended Varistor; Maximum Energy: more than 1J
(However, please make settings using values that take into consideration the worst case scenario.)

Varistor voltage: For 12 V DC input, Min. 18 V

Ex. 2: When using a zener diode (circuit)

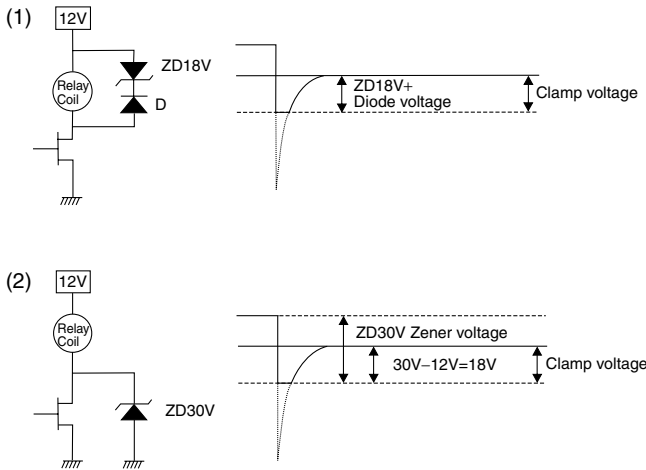

- 4) Lifetime is specified under the standard test conditions in JIS C 5442. (temperature 15 to 35°C 59 to 95°F, humidity 25%RH to 85%RH)

Lifetime is dependent on the coil driving circuit, load type, operation frequency and ambient conditions. Check lifetime under the actual condition.

Especially, Contact terminals have polarity. So if the contact terminals were connected with opposite pole, the electric life would be shorter.

- 5) When applying current which includes precipitous changes or ripple, the relay may generate buzzing sound. Therefore, please confirm with the actual load.
- 6) If the relay is used while exceeding the coil rating, contact rating or cycle lifetime, this may result in the risk of overheating.
- 7) As a general rule, do not use a relay if it has been dropped.
- 8) Take care to avoid cross connections as they may cause malfunctions or overheating.
- 9) When the screws for fixing relay-body and for additional terminal are tightened, it should be used within the range of decided torque.
- 10) Avoid mounting the relay in strong magnetic fields (near a transformer or magnet) or close to an object that radiates heat.
- 11) If the several relays are mounted closely or a heat-generation object is close to the relay, take care to check the abnormal temperature-rise and the insulation distance between the terminals outside of the relay.

12) The relay contacts are encapsulated in an inert gas atmosphere. Care must be exercised when the relay is to be used or stored at high ambient temperature.

13) If the power is turned off and then immediately on after applying the rated voltage (current) continuously to the relay's coil and contact, the resistance of the coil will increase due to a rise in the coil temperature.

This causes the pick-up voltage to rise, and possibly exceed the rated pick-up voltage. In these circumstances, take measures such as reducing the load current, limiting the duration of current flow, and applying a coil voltage higher than the rated operating voltage (quick start).

14) In case using a capacitive load (C-load), please take a countermeasure as pre-charging to the capacitive load so that the inrush current will not surpass 60A.

The relay might have a contact welding without such countermeasure.

15) If the relay is used for an inductive load (L load) such that $L/R > 1\text{ms}$, add surge protection in parallel with the inductive load. If this is not done, the electrical life will decrease and cut-off failure may occur.

16) Use the suitable wire for wire at the load side according to the current. If the wire diameter is small, the maximum rated contact current cannot be guaranteed.

(Ex.) Carrying current; 60A: diameter of 15mm² or more

17) Take care to disconnect to the power supply when wiring.

18) Do not switch the contacts without any load as the contact resistance may become increased rapidly.

19) The relay satisfies the protection level of JIS D 0203 R2 (of waterproof). Please take any countermeasures additionally if it should be installed in the place where higher protection level is required.

20) Do not use this product in such atmosphere where any kind of organic solvent (as benzene, thinner and alcohol) and the strong alkali (as ammonia and caustic soda) might be adhered to this product.

21) Be careful that foreign matter and oils and fats kind don't stick to the main terminal parts because it is likely to cause terminal parts to give off unusual heat.

22) Do not make additional manufacturing upon the relay housing.

23) For AC shutoff there is no contact polarity, but confirm the electric life using the actual load.

For general cautions for use, please refer to the "CAUTIONS FOR USE OF AUTOMOTIVE RELAYS"

<http://industrial.panasonic.com/ac/e/>